

# SINKS 2013

COLOUR  
YOUR LIFE



# CRISTALITE+®

Pages 4-11

The new generation of Cristalite has been developed over 30 years and now features substantially improved properties. It is now even easier to clean and has a new intensity of colour.

CRISTALITE is food-safe, UV stable and all sinks are finished with Schock Antibac. This natural antibacterial protection system, developed by Schock, inhibits 95% of bacterial growth, which makes doing kitchen chores a more hygienic and carefree experience.

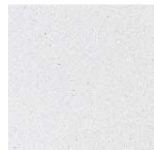

Alpina

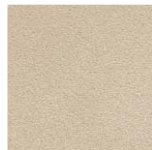

Colorado



Nero



Titanium



Onyx



Croma



Lava



Pera

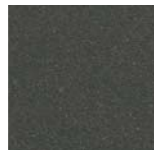

Mocha

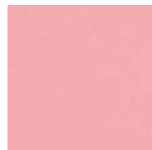

Pink\*



Orange\*



Sunflower\*



Ocean Blue\*



Peppermint\*

\*Bright colours available only with the Nemo see page 13

# SCHOCK COLOUR YOUR LIFE

## Granite Sinks

Around 80% of the material used in Schock sinks is quartz, the hardest constituent of granite. Thus, they are well known as 'granite sinks'. The granite used in Schock sinks is combined with high grade acrylic to produce a hardened composite material that is resistant to scratches, cracking, stains and is responsible for the long life of the sinks.

The world of Schock materials currently comprises of two materials, both developed in-house in Germany by Schock. More than 40 active patents demonstrate the company's leading position and its unique capacity for innovation in the field of granite sinks.

## CARE & CLEANING

### Daily regular cleaning:

Clean using washing-up liquid and hot water.

### Stubborn Stains:

Clean using Cream cleaner with a 'Scotchbrite Pad'

### Mineral Deposits:

Soak in a solution of 3 parts hot water and 1 part white vinegar.

### Aluminium Marks:

Remove by using 'Shiny sink' or 'Astonish' paste.

### Bleach Cleaning: (only recommended with Cristalite not Cristadur)

Use diluted solution - avoid soaking for long periods as this can damage the steel/chrome waste fitting.

### After Cleaning:

Always rinse with clean water to remove any cleaner residue and then dry off with a soft cloth to prevent limescale build-up.



## Topmount

This installation requires the sink to be mounted into the work top from the top. This installation type is suitable for all work top types including laminated chipboard.



## Undermount

This installation requires the sink to be fitted to the work top from the underside. This installation type is only suitable for solid surface work tops such as Granite, Marble or wood.



## CRISTADUR® Pages 12-17

In addition to the great attributes of CRISTALITE+ the premium CRISTADUR material has an ultra-fine structure resulting in unprecedented ease of care and featuring a dirt repellent effect (the dirt simply runs off). Dirt that could be a breeding ground for bacteria finds it impossible to stick to the material. An added benefit of CRISTADUR is its silky-smooth surface - it's wonderfully soft to touch whilst offering maximum resistance to stains and scratches.

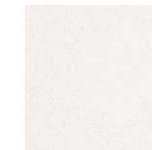

Polaris

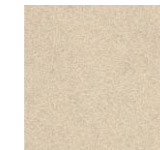

Avorio



Carbonium



Bronze

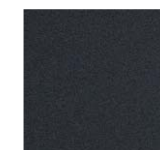

Magma



### Easy Care Set Ref. 629018

Includes:  
Cleaner (alcohol based)  
Brightener  
Abrasive wipe sponge

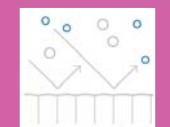

Dirt Repellent - the dirt simply runs off

# PRIMUS CRISTALITE<sup>+</sup>

The **Primus's** restrained styling and competitive pricing have ensured this range to be one of our most popular. The single bowl model boasts a particularly generously dimensioned bowl - great for big things!



A really useful drain recess on the D 100 - ideal for emptying leftover drinks when the washing bowl is in use.



A neat solution for disguising the overflow

## COLOURS See page 2



Alpina



Onyx



Colorado



Mocha



## ACCESSORIES



Ref. 629171  
Wire Basket



Ref. 629036  
Glass Chopping Board



Ref. 629043  
Stainless Steel Colander



## The Perfect Match

For the first time it is possible to achieve a 100% colour match with the sink and tap. A patented sheathing technique has been developed by Schöck. The Cristalite/Cristadur casing also ensures extreme durability and will withstand impacts with heavy pots and extremes of temperature - it bravely stands up to the rigours of the busy kitchen - so chipped paint on lacquered taps is a thing of the past.

Recommended range see page 19.

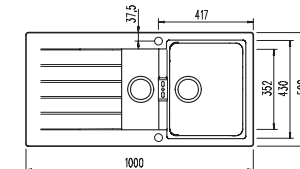
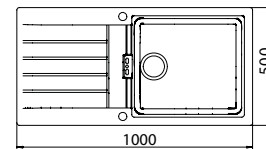

### Ref. PRI D 100

**Primus** single bowl and drainer

Installation: Topmount  
Overall size: 1000/500 mm  
Cutout size: 980/480 mm  
Bowl size: 478/430/195 mm  
Minimum cabinet size: 600 mm  
Reversible knockout tap-holes  
Waste included

### Ref. PRI D 150

**Primus** 1.5 bowl and drainer

Installation: Topmount  
Overall size: 1000/500 mm  
Cutout size: 980/480 mm  
Bowl size: 344/430/195 mm  
Half bowl size: 159/352/120 mm  
Minimum cabinet size: 600 mm  
Reversible knockout tap-holes  
Waste & connecting kit included



Ref. 629830  
Comfotouch  
see page 19



# DOMUS CRISTALITE+®

The **Domos** sinks have sharp geometric lines, providing cutting edge minimalism in the kitchen. Its many design attributes include a deeply recessed drainer that helps contain spills and accommodates a glass chopping board that can slide across both the drainer and bowls. It is also slightly larger than most of its peers, thus enabling it to be fitted as a replacement sink without the need to renew expensive work surfaces.

See page 2 to learn more about Cristalite and get a better view of the colours.



## ACCESSORIES



Ref. 629033  
Glass Chopping Board

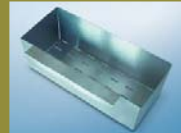

Ref. 629047/N  
Stainless Steel Colander

## COLOURS See page 2



Alpina



Colorado



Onyx



Titanium

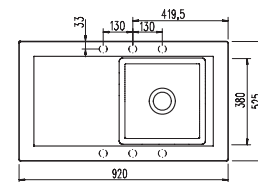

### Ref. DOM D 100 Domus single bowl and drainer

Installation: Topmount  
Overall size: 920/525 mm  
Cutout size: 840/480 mm  
Bowl size: 379/380/203 mm  
Minimum cabinet size: 450 mm  
Reversible knockout tap-holes  
Waste included

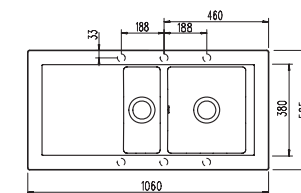

### Ref. DOM D 150 Domus 1.5 bowl and drainer

Installation: Topmount  
Overall size: 1060/525 mm  
Cutout size: 980/480 mm  
Bowl size: 343/380/203 mm  
Half bowl size: 161/380/200 mm  
Minimum cabinet size: 600 mm  
Reversible knockout tap-holes  
Waste & connecting kit included

## The Perfect Match

Unique to Schock sinks - a perfectly colour matched range of recommended taps, see page 19.



Ref. 629830  
Comfotouch  
see page 19



# CAMPUS

## CRISTALITE<sup>+</sup>

The **Campus** sinks have a few more curves than our other Schöck models and blend in beautifully in both modern and more traditional kitchens. Both these sinks have really useful accessories that add to their versatility. The single bowl model also has a usefully large bowl for the ever growing oven trays. See page 2 to learn more about Cristalite and get a better view of the colours.

### ACCESSORIES



**Wire Basket**  
Ref. 629149 (D100L)  
Ref. 629147 (D150)  
*illustrated*



**Ref. 629036**  
Glass Chopping Board  
*(for topmount installation only)*



**Ref. 629041**  
Stainless Steel Colander



**Ref. CAM D 100**  
**Campus** single bowl and drainer

Installation: Topmount  
Overall size: 1000/500 mm  
Cutout size: 980/480 mm  
Bowl size: 464/435/220 mm  
Minimum cabinet size: 600 mm  
Reversible knockout tap-holes  
Waste included

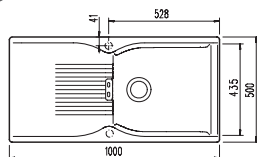

**Ref. CAM D 150**  
**Campus** 1.5 bowl and drainer

Installation: Topmount  
Overall size: 1000/500 mm  
Cutout size: 980/480 mm  
Bowl size: 347/435/200 mm  
Half bowl size: 137/435/125 mm  
Minimum cabinet size: 600 mm  
Reversible knockout tap-holes  
Waste & connecting kit included

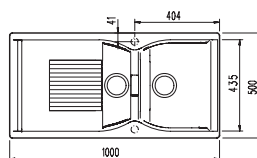

**COLOURS See page 2**



Removable overflow fascia

# VENUS

## CRISTALITE<sup>+</sup>

Subtle sculptured lines and curves combine in the cool styling of the **Venus** to create a very stylish sink that will look great in both contemporary and traditional kitchen settings. See page 2 to learn more about Cristalite and get a better view of the colours.

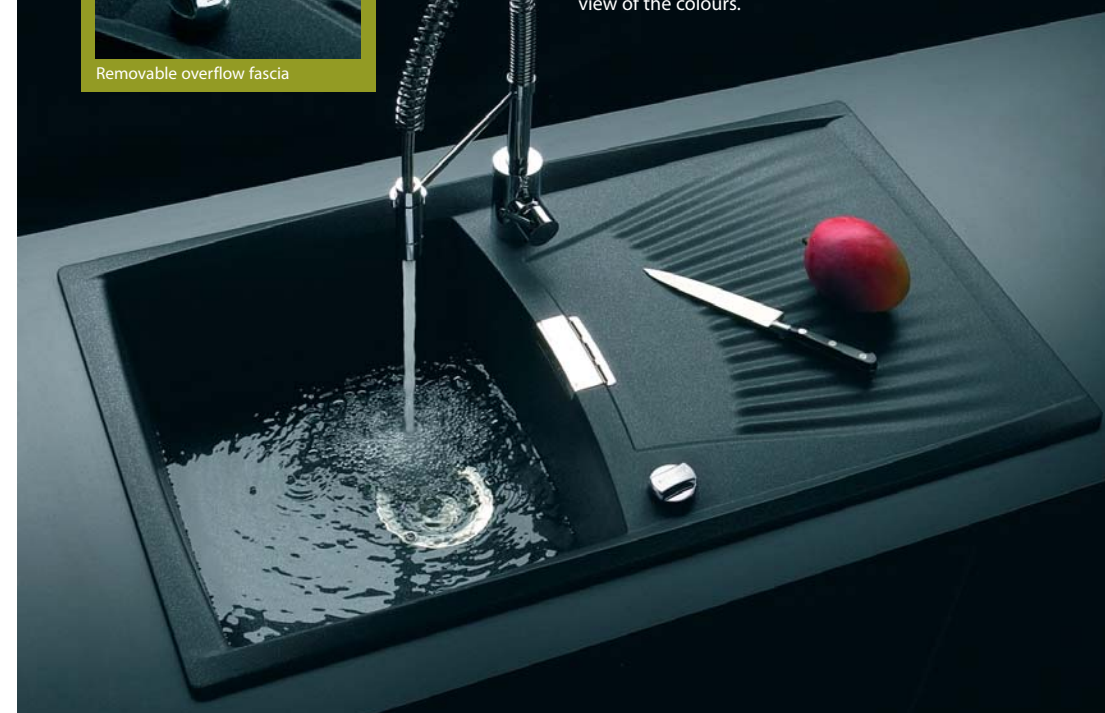

**COLOURS See page 2**



**Ref. VEN D 100**  
**Venus** single bowl and drainer

Installation: Topmount  
Overall size: 862/502 mm  
Cutout size: 840/480 mm  
Bowl size: 378/441/195 mm  
Minimum cabinet size: 500 mm  
Reversible knockout tap-holes  
Waste included

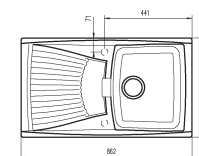

**Ref. VEN D 150**  
**Venus** 1.5 bowl and drainer

Installation: Topmount  
Overall size: 1002/502 mm  
Cutout size: 980/480 mm  
Bowl size: 339/439/202 mm  
Half bowl size: 168/293/137 mm  
Minimum cabinet size: 600 mm  
Reversible knockout tap-holes  
Waste & connecting kit included

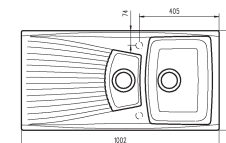

Recommended  
Schöck Taps  
See page 19

# LITHOS

CRISTALITE<sup>+</sup>



The **Lithos** is our entry level Granite sink and offers great value for money, they are made in Germany using the same Cristalite<sup>+</sup> material as their more expensive cousins. The restrained elegance of these sinks is timeless and makes them an ever popular choice.

## COLOURS

See page 2



Colorado



Alpina



Lava



Pera



Mocha



Nero



Onyx



Croma



Titanium

## ACCESSORIES



Ref. BS201  
Chrome  
Basket



Ref. COL104  
Acrylic (clear)  
Colander



Ref. GBD500  
Glass Chopping  
Board

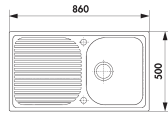

Ref. EV501  
**Lithos** single bowl and drainer

Installation: Topmount  
Overall size: 860/500 mm  
Cutout size: 840/480 mm  
Bowl size: 347/421/205 mm  
Minimum cabinet size: 450 mm  
Reversible knockout tap-holes  
Waste included

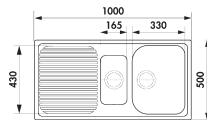

Ref. EV511  
**Lithos** 1.5 bowl and drainer

Installation: Topmount  
Overall size: 1000/500 mm  
Cutout size: 980/480 mm  
Bowl size: 340/421/205 mm  
Half bowl size: 161/299/140 mm  
Minimum cabinet size: 600 mm  
Reversible knockout tap-holes  
Waste & connecting kit included

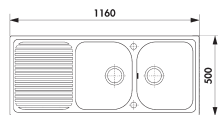

Ref. EV502  
**Lithos** double bowl and drainer

Installation: Topmount  
Overall size: 1160/500 mm  
Cutout size: 1140/480 mm  
Bowl size (both): 340/421/205 mm  
Minimum cabinet size: 800 mm  
Reversible knockout tap-holes  
Waste & connecting kit included

# GENIUS

CRISTALITE<sup>+</sup>

The **Genius** features attractive 'fade-away' draining grooves that flow into a half-moon half bowl with one model and into an elliptical drainer recess with the single bowl model – this feature is particularly useful for the disposal of liquids when the main bowl is in use.

## ACCESSORIES



Ref. 629036  
Glass Chopping Board

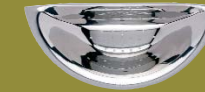

Ref. COL629042  
Stainless Steel Colander

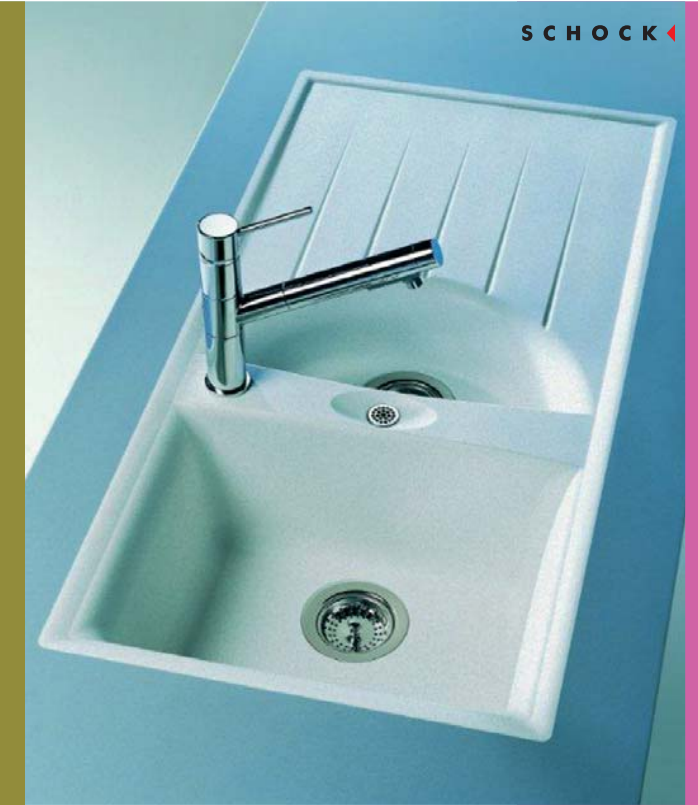

## COLOURS

See page 2



Onyx



Titanium



Alpina



Colorado

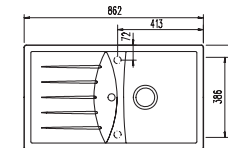

Ref. GEN D 100  
**Genius** single bowl and drainer

Installation: Topmount  
Overall size: 862/502 mm  
Cutout size: 840/480 mm  
Bowl size: 319/386/196 mm  
Minimum cabinet size: 450 mm  
Reversible knockout tap-holes  
Waste included

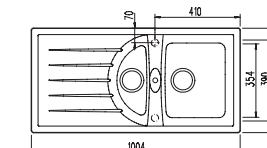

Ref. GEN D 150  
**Genius** 1.5 bowl and drainer

Installation: Topmount  
Overall size: 1004/502 mm  
Cutout size: 980/480 mm  
Bowl size: 314/390/195 mm  
Half bowl size: 153/354/108 mm  
Minimum cabinet size: 600 mm  
Reversible knockout tap-holes  
Waste & connecting kit included



Recommended  
Schock Taps  
See page 19



## SOLIDO CRISTALITE +

The **Solido** are a very chic collection of undermounted sinks that are infinitely flexible: just choose one bowl or mix two together for whatever combination suits best. The new 1.75 bowl is the latest addition and offers the complete washing-up experience.

See page 2 to learn more about Cristalite and get a better view of the colours.



Ref. SOL N 50 Solido single bowl



Ref. SOL N 75 Solido single bowl



Ref. SOL N 100 Solido single bowl

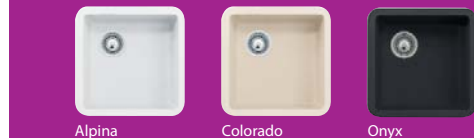

Ref. SOL N 150 Solido 1.5 bowl

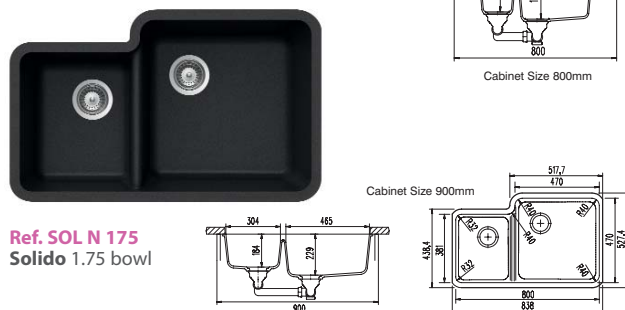

Ref. SOL N 175 Solido 1.75 bowl

## NEMO CRISTALITE +

The **Nemo** can be used as a principle or secondary sink. It is Topmounted with a tap-ledge; available in seven great colours including five fun pastel colours that will add a little sunshine to your kitchen. Don't forget the accessories which really widen this sink's versatility.

### ACCESSORIES



Ref. 629017 Stainless Steel Colander



Ref. 629015 Glass Chopping Board



Recommended Schock Taps See page 19



Ref. NEMO N-100 S Nemo single bowl

Installation: Topmount  
Overall size: 490/510 mm  
Cutout size: 470/490 mm  
Bowl size: 434/373/180  
Minimum cabinet size: 500 mm  
Waste included

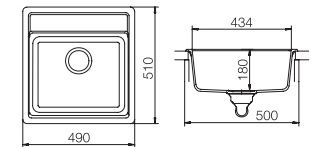

### COLOURS See page 2

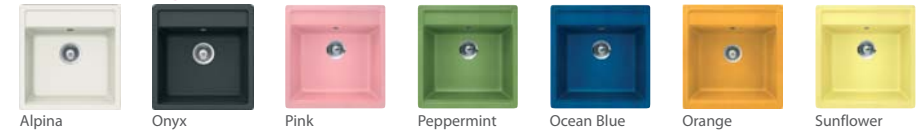

## QUADRO CRISTALITE +

The **Quadro** is a contemporary tight radius cornered sink with a very crisp design profile.

Ref. QUA N 150 Quadro 1.5 single bowl

Installation: Undermount  
Overall size: 550/430mm  
Cutout size: 520/400 mm  
Bowl size: 310/370/200 mm  
Half bowl size: 152/370/130 mm  
Minimum cabinet size: 600 mm  
Waste & connecting kit included

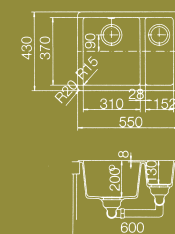

### COLOURS See page 2

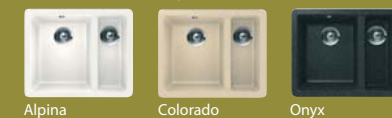



The **Signus** is available in a compact single bowl with drainer recess and a versatile 1.5 bowl option. Both models share the same ever contemporary linear drainer design and rectilinear bowls that will add cool sophistication to your kitchen.

COLOURS See page 3



Polaris



Avorio



Magma

# MODENA

CRISTADUR®

The **Modena** is our entry level priced Cristadur sink offering great value for money. It's modern shape is emphasised by the 25mm radius bowls and distinct draining grooves. The single bowl also benefits from a drainer waste recess ideal for disposing of liquids when the main bowl is in use.

## ACCESSORIES

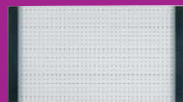

Ref. 629036  
Glass Chopping Board



Ref. 629044  
Bamboo Chopping Board



Ref. 62912448  
Acrylic (clear) Colander



Ref. 629171  
Chrome Wire Basket



Recommended Schock Taps  
See page 19

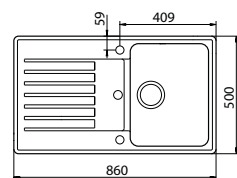

**Ref. MOD D 100**  
**Modena** single bowl and drainer

Installation: Topmount  
Overall size: 860/500 mm  
Cutout size: 840/480 mm  
Bowl size: 331/433/200 mm  
Minimum cabinet size: 450 mm  
Reversible knockout tap-holes  
Waste included

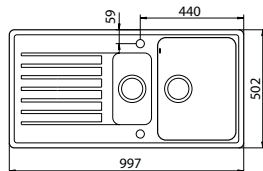

**Ref. MOD D 150**  
**Modena** 1.5 bowl and drainer

Installation: Topmount  
Overall size: 997/502 mm  
Cutout size: 980/480 mm  
Bowl size: 332/439/200 mm  
Half bowl size: 163/304/150 mm  
Minimum cabinet size: 600 mm  
Reversible knockout tap-holes  
Waste & connecting kit included



A neat solution for disguising the overflow

A really useful drain recess on the D 100 L - ideal emptying leftover drinks when the washing bowl is in use.

## ACCESSORIES



Ref. 629036  
Glass Chopping Board



Ref. 629171  
Chrome Wire Basket



Ref. 629043  
Stainless Steel Colander

COLOURS See page 3



Polaris



Magma



Carbonium



Avorio

**Ref. SIG D 100**  
**Signus** single bowl and drainer

Installation: Topmount  
Overall size: 860/500 mm  
Cutout size: 840/480 mm  
Bowl size: 347/430/195 mm  
Minimum cabinet size: 450 mm  
Reversible knockout tap-holes  
Waste included

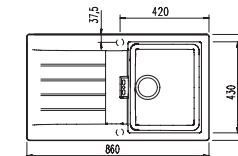

**Ref. SIG D 150**  
**Signus** 1.5 bowl and drainer

Installation: Topmount  
Overall size: 1000/500 mm  
Cutout size: 980/480 mm  
Bowl size: 344/430/195 mm  
Half bowl size: 159/352/120 mm  
Minimum cabinet size: 600 mm  
Reversible knockout tap-holes  
Waste & connecting kit included

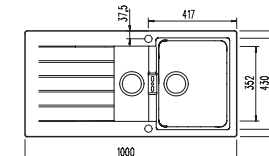

Ref. 629830  
Comfortouch  
see page 19



# WATERFALL CRISTADUR®



The **Waterfall's** flowing drainer is not only uniquely stylish but drains off water quicker than you can say Jack Robinson! This imaginative design also hasn't compromised its functionality in that the bowls in both models are a good working size. The Waterfall will certainly be a talking point in any kitchen.

**COLOURS** See page 3



Magma



Polaris



Bronze



Carbonium

See page 3 to learn more about Cristadur and get a better view of the colours.



# FOCUS CRISTADUR®

The **Focus** has won not one but two design awards. Its most notable feature is the round half bowl and its coordinated stainless steel strainer specially produced by the premium manufacturer Rosle.

**COLOURS** See page 3



Avorio



Polaris



Magma

**ACCESSORIES**



Ref. 629046  
Black Glass Chopping Board



Ref. 629045  
White Glass Chopping Board



Ref. 629049  
White Strainer Bowl



Ref. 629049G  
Green Strainer Bowl



Recommended Schock Taps  
See page 19

**ACCESSORIES**



Ref. 629046  
Black Glass Chopping Board



Ref. 629045  
White Glass Chopping Board



Ref. 629107  
Stainless Steel Colander



Ref. 629195  
Chrome Basket

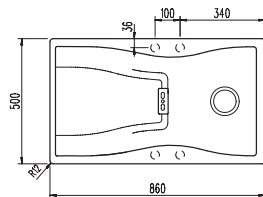

**Ref. WAT D 100**  
**Waterfall single bowl and drainer**

Installation: Topmount  
Overall size: 860/500 mm  
Cutout size: 840/480 mm  
Bowl size: 354/435/184 mm  
Minimum cabinet size: 500 mm  
Reversible knockout tap-holes  
Waste included

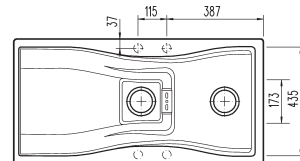

**Ref. WAT D 150**  
**Waterfall 1.5 bowl and drainer**

Installation: Topmount  
Overall size: 1000/500 mm  
Cutout size: 980/480 mm  
Bowl size: 334/435/184 mm  
Half bowl size: 170/173/138 mm  
Minimum cabinet size: 600 mm  
Reversible knockout tap-holes  
Waste & connecting kit included

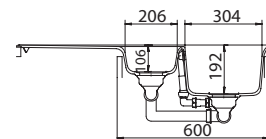
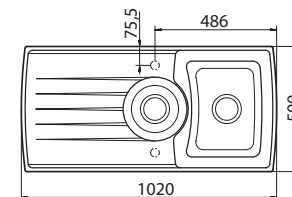
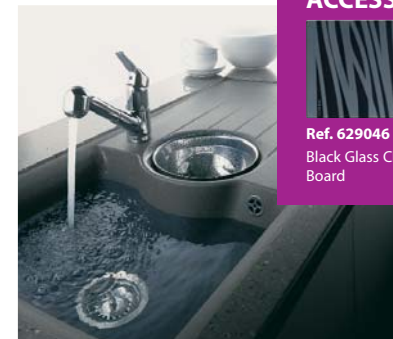

**Ref. FCO D 150**  
**Focus 1.5 bowl and drainer**

Installation: Topmount  
Overall size: 1020/500 mm  
Cutout size: 980/480 mm  
Bowl size: 304/403/192 mm  
Half bowl size: 206 mm diameter  
Minimum cabinet size: 600 mm  
Reversible knockout tap-holes  
Waste & connecting kit included



Recommended Schock Taps  
See page 19



Ref. 629830  
Comfotouch  
see page 19

# HORIZONT CRISTADUR®



Granite

COLOURS  
See page 3



Polaris



Magma



Carbonium



Avorio

The **Horizont** have a subtly sophisticated design employing all the minimalist rules but with an added flourish, for example, the sheer drainer has a unique central draining channel and the 1.5 bowl model has had the half bowl unusually positioned on the outside of the main bowl. The crowning glory for the D150 model only is a pair of sleek black glass chopping boards that slide elegantly across the sink, when not in use the sink can be 'closed off' creating a calm and uncluttered effect.



Ref. 629051  
Stainless Steel  
Colander

## ACCESSORIES



**Black Glass Boards**  
Ref. 629076 (D100)  
Ref. 629075 (D150) Large  
Ref. 629064 (D150) Small

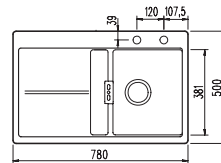

**Ref. HON D 100**  
**Horizont** single bowl and drainer  
Installation: Topmount  
Overall size: 780/500 mm  
Cutout size: 760/480 mm  
Bowl size: 310/381/195 mm  
Minimum cabinet size: 400 mm  
Reversible knockout tap-holes  
Waste included

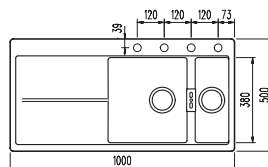

**Ref. HON D 150**  
**Horizont** 1.5 bowl and drainer  
Installation: Topmount  
Overall size: 1000/500 mm  
Cutout size: 980/480 mm  
Bowl size: 353/380/195 mm  
Half bowl size: 150/380/120 mm  
Minimum cabinet size: 600 mm  
Reversible knockout tap-holes  
Waste & connecting kit included

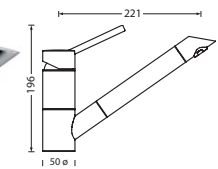

**Ref. SC-200**  
Single lever monobloc  
with swivel spout

Cristalite /Chrome  
Cristadur /Chrome

Min. 0.5 bar pressure required  
360° swivel spout  
Sheathed in either  
Cristalite or Cristadur  
WRAS approved  
Mounting hole size Ø 35mm

## CRISTADUR

- Polaris
- Carbonium
- Avorio
- Magma
- Bronze

# TAPS

## The Perfect Match

Our Schock taps are the perfect match for all Schock sinks; they have been clad in actual Cristalite and Cristadur material which means they are a perfect colour and material match to the sink. Also, as the material is incredibly robust there will be very little chance of deterioration with regard to scuffing, scratching or discolouration.



Scratch and chip resistant.



**Ref. SC-300**  
Single lever monobloc  
with swivel spout

Cristalite /Chrome  
Cristadur /Chrome

Min. 0.5 bar pressure required  
360° swivel spout  
Sheathed in either Cristalite or Cristadur  
WRAS approved  
Mounting hole size Ø 35mm

## CRISTALITE

- Alpina
- Colorado
- Lava
- Pera
- Titanium
- Onyx
- Croma
- Nero



**Ref. SC-40**  
Single lever monobloc  
with swivel spout

Cristalite /Chrome

Min. 0.5 bar pressure required  
360° swivel spout  
Sheathed in Cristalite  
WRAS approved  
Mounting hole size Ø 35mm

## comfotouch SCHOCK



A SOFT  
TOUCH IS ALL  
IT TAKES

The **Comfotouch** is an electrically powered automatic waste. The control is a sophisticated brushed steel touch sensitive button - one light touch is all that is needed to open or close the waste plug. The system is powered by a mains powered transformer which is CE safety certified.

**Ref. 629830**  
**Comfotouch**  
Automatic  
Waste

